

KAESER
COMPRESSORS

Built for a lifetime.™



Regenerative Desiccant Dryers

KAD, KED, KBD, and Hybritec Series

www.kaeser.com

Desiccant Air Dryers

The right dryer for you

Most compressed air applications can achieve the required air quality by using a refrigerated dryer in combination with proper filtration. However, in cases where compressed air is exposed to freezing temperatures or where the product, process, or equipment is highly sensitive to moisture, Kaeser offers a complete line of desiccant dryers specifically designed to meet low dew points and deliver energy savings.

Innovation you can trust

With a cutting edge research and development team committed to building industry-leading products, Kaeser continues to deliver better solutions to meet our customers' compressed air needs. Kaeser's expertise and world-wide reputation for superior reliability and efficiency offer great performance and peace of mind.

Quality in every detail

Desiccant dryer performance and reliability are driven by component quality. Kaeser's valves and actuators are designed for consistent dew point performance and low pressure drop. Additionally, desiccant bed symmetry is selected to ensure uniform flow distribution and maximize contact time, while the spherical activated alumina desiccant allows for long service life and minimizes dusting. It also has a high surface-to-volume ratio and great affinity for water vapor for superior adsorption.

Savings with proper application

Proper planning with the help of Kaeser's system design engineers can save you money on capital and energy costs. Desiccant dryers have a higher purchase price and overall operating costs than refrigerated dryers and should be applied to the portions of a system requiring dew points below that of a refrigerated dryer. Kaeser can design a system that will efficiently deliver air quality suitable for your application.

Desiccant dryer basic operation

Kaeser desiccant dryers use the principles of adsorption and desorption and alternately cycle the compressed air through twin desiccant towers. As the vapor-laden air flows through one tower, the moisture is adsorbed onto the desiccant. Meanwhile, in the other tower, "purge air" flows through, evaporates the water on the desiccant, and carries it out of the tower as vapor.

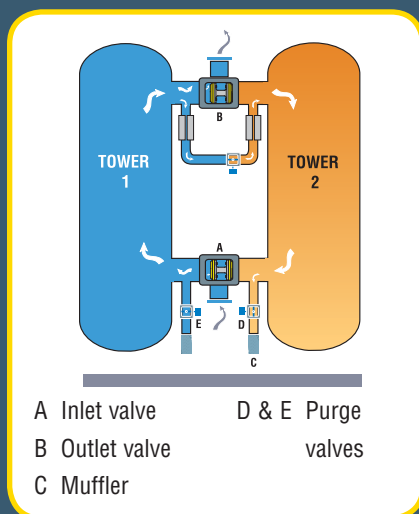

The Benefits of Counterflow Regeneration

Kaeser's upflow drying and downflow regeneration extends desiccant service life and ensures consistent outlet dew points.

Upflow drying also controls the accumulation of liquid water in the desiccant beds. Regardless of design, liquid water will accumulate in the piping between the prefilters and the dryer inlet. Eventually, the air stream will carry a "slug" of water into the desiccant bed.

Counterflow design ensures that the driest portion of the desiccant bed is nearest the dryer outlet at switchover, and allows purge air to be evenly distributed throughout the desiccant bed, providing more effective regeneration.

KAESER

KAESER
COMPRESSORS
1-800-279-3247



Heatless Desiccant Dryer (KAD)

KADs produce pressure dew points as low as -100°F at rated conditions (see Dew Point Options on page 5).

Sizes: 40 – 5400 scfm

Controls and instrumentation

- Tower pressure gauges
- Tower status lights
- Switching failure alarm*
- Purge flow indicator
- NEMA 4 electrical enclosure
- RS232 comm port*

*Not available on KAD E

Separate top fill and bottom drain ports

- Easy desiccant replacement and removal

ASME stamped pressure vessels

- Fabricated per Section VIII of the boiler and pressure vessel code
- ASME pressure relief valve

Standard purge pressure adjusting valve

- Offers convenient purge rate adjustment

Inlet and outlet shuttle valves

- Nylon shuttle
- Tested to over 500,000 cycles
- Corrosion resistant aluminum housing
- Single moving part has very long life
- No maintenance
- No check valves

Standard moisture indicator

- Color change indicates elevated outlet dew point

Standard stainless steel support screens and air diffusers

- Located internally at top and bottom of each vessel
- Easy to remove and clean
- Efficiently filters out large contaminants and protects outlet shuttle valve
- Effectively prevents channeling

Structural steel frame complete with floor stand for easy installation

- Lifting lugs for easy handling
- Optional factory mounting of pre- and after-filters

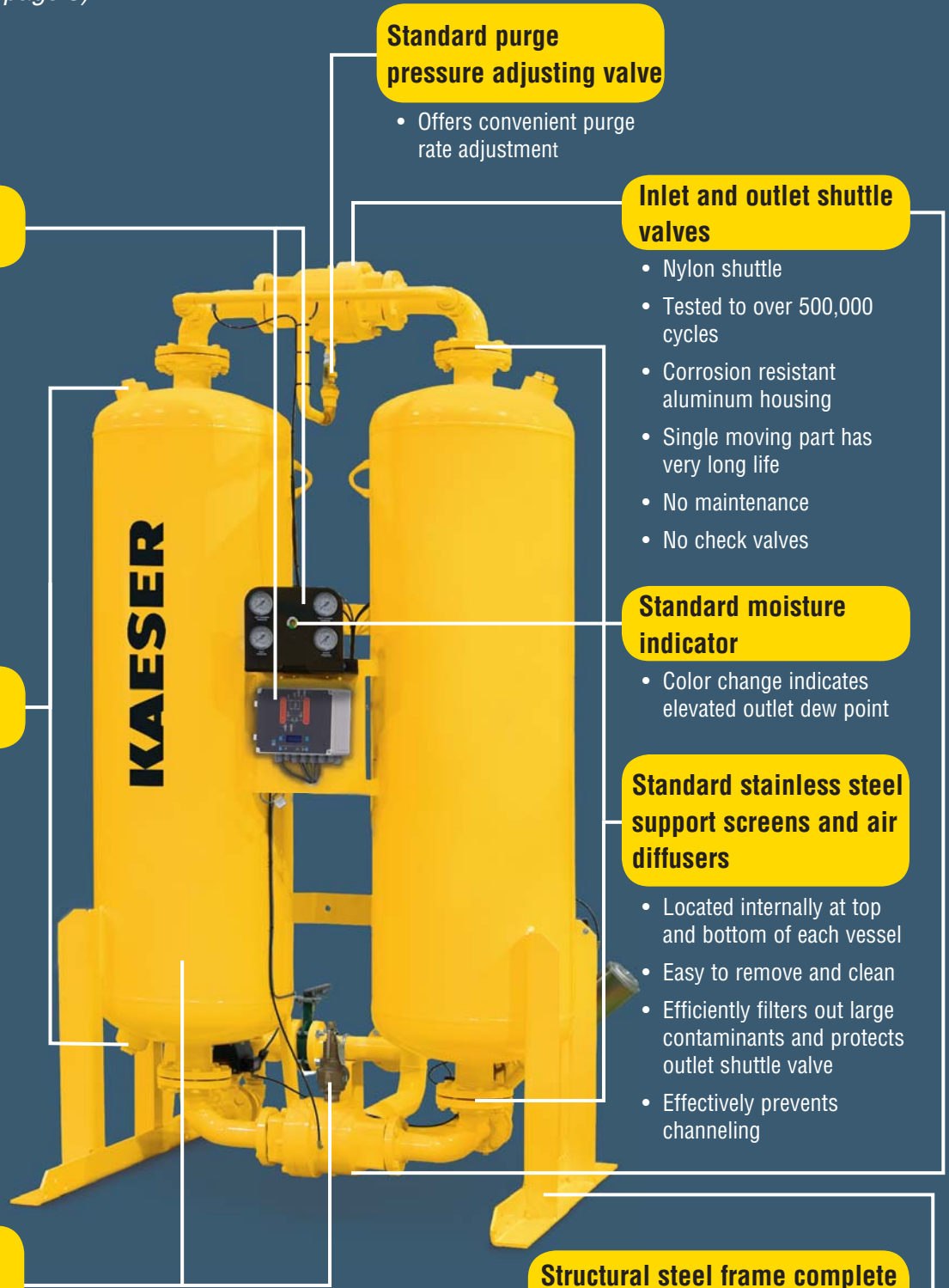

Specifications for KAD (Table 1)

All Models (E and PS)	Inlet Flow @ 100 psig (scfm)	Purge Rate @ 100 psig (scfm)		Outlet Air Flow Rate (scfm)		Power Supply	Dimensions* W x D x H (inches)	Inlet and Outlet Connection* (inches)	Weight (lb.)	Filter Package Capacity (scfm)	Total Replacement Desiccant (lb.)
		Avg	Max	Avg	Min						
KAD 40	40	5.8	7	34.2	33.0	KAD and KAD PS: 100-240 V 1 Ph 50 or 60 Hz	31 x 32 x 49	1 NPT	365	60	52
KAD 60	60	8.6	10.5	51.4	49.5		31 x 32 x 64		445	60	80
KAD 90	90	13	15.8	77.0	74.2		31 x 32 x 81		575	100	110
KAD 115	115	16.6	20.1	98.4	94.9		42 x 38 x 57	685	170	210	
KAD 165	165	23.8	28.9	141	136		47 x 38 x 75	1010	375	318	
KAD 260	260	37.4	45.5	223	215		55 x 38 x 65	1215	375	458	
KAD 370	370	53.3	64.8	316	305		55 x 38 x 73	1350	485	542	
KAD 450	450	64.8	78.8	385	371		49 x 48 x 104	1473	625	708	
KAD 590	590	85	103	505	487		50 x 48 x 107	2134	780	906	
KAD 750	750	108	131	642	619		55 x 56 x 112	2414	1000	1180	
KAD 930	930	134	163	796	767		59 x 56 x 115	2875	1250	1420	
KAD 1130	1130	163	198	967	932		60 x 56 x 120	3722	1875	1846	
KAD 1350	1350	194	236	1156	1114		66 x 56 x 117	4167	1875	2064	
KAD 1550	1550	223	271	1327	1279		72 x 56 x 119	4417	2500	2520	
KAD 2100	2100	302	368	1798	1732		76 x 62 x 125	9010	3125	3734	
KAD 3000	3000	432	525	2568	2475		85 x 62 x 124	9900	5000	5398	
KAD 4100	4100	590	718	3510	3382	96 x 66 x 124	12,000	6875	7200		
KAD 5400	5400	778	945	4622	4455						

Note 1: KAD dryer inlet flow capacities are established in accordance with CAGI (Compressed Air and Gas Institute) Standard ADF-200: Inlet air pressure 100 psig, inlet air temperature 100°F, saturated.

Note 2: The purge flow rate of any pressure swing (heatless) desiccant dryer is not constant throughout the purge cycle. The purge cycle consists of a maximum purge flow period when the purge valve is open and a reduced flow period during repressurization. The total air consumption during the purge cycle is the average purge flow and is based on a 10 minute cycle time (-40°F PDP).

Note 3: Maximum working pressure: 150 psig standard; 250 psig optional. Maximum working pressure to 500 psig available for most models. Consult factory.

*Dryer only. May vary with filter package.

Flow Capacities

Maximum inlet flow capacities at various pressures:

To determine a dryer's inlet flow capacity at inlet pressures other than 100 psig, multiply the dryer's rated inlet flow (found in Table 1) by the multiplier from Table 2 that corresponds to the system pressure at the dryer inlet.

Outlet flow capacities:

For dryers operating at less than maximum flow and using the Purge Economizer feature and/or operating at pressures other than 100 psig, contact factory for correct purge flow.

Specifications are subject to change without notice.

KAD Inlet Pressure Correction Factor (Table 2)

Inlet Pressure (psig)	Multiplier	Inlet Pressure (psig)	Multiplier
60*	0.65	130	1.12
70	0.74	140	1.16
80	0.83	150	1.20
90	0.91	175	1.29
100	1.00	200	1.37
110	1.04	225	1.45
120	1.08	250	1.52

*For operation at pressures lower than 60 psig, please contact factory.

(Table 3)

ISO 8573.1 Class	Dew Point	Cycle Time and Mode	
		Standard	with Optional Purge Saver**
1	-100°F (-73°C)*	4 min. fixed	N/A
2	-40°F (-40°C)	10 min. fixed	Yes
3	-4°F (-20°C)	16 min. fixed	Yes
4	+38°F (+3°C)	24 min. fixed	Yes

* This performance exceeds Quality Class 1 set at -94°F (-70°C)

** The Purge Saver controller also offers fixed cycle settings

KAD Dew Point Options Meet ISO 8573.1 Air Quality Standards (Table 3)

Models KAD and KAD PS allow the user to select outlet pressure dew points corresponding to four of the different ISO 8573.1 air quality classes.

KAD E models are preset to deliver the commonly used ISO 8573.1 Class 2 outlet pressure dew point.

Heated Desiccant Dryers (KED & KBD)

Kaeser Heated Purge Dryers (KED) are heated regenerative dryers that use only 7% of compressed air for purging. They heat the dry purge air to increase its capacity to hold moisture and to regenerate. KED's provide lower operating costs by reducing the amount of expensive purge air used to regenerate. Standard design outlet pressure dew point at rated conditions: -4°F (-40°F with the optional purge booster).

Sizes: 300 – 3200 scfm

Kaeser Blower Purge Dryers (KBD) use little or no purge air by introducing atmospheric air and heating it. The heated air has a higher capacity for absorbing water and provides effective regeneration. KBD's provide the greatest energy savings by eliminating the need to use costly compressed air for purging. Standard design outlet pressure dew point at rated conditions: -40°F.

Sizes: 500 – 4300 scfm standard. Up to 10,000 scfm available, consult factory.



Standard stainless steel support screens and air diffusers

- Located internally at top and bottom of each vessel
- Easy to remove and clean
- Efficiently filters out large contaminants and protects outlet shuttle valve
- Effectively prevents channeling

Standard pressure relief valve

- Meets ASME Section VIII

Standard moisture indicator

- Samples outlet air
- Color change indicates elevated outlet dew point (not shown)

Standard purge flow valve (KED only)

- Offers convenient purge rate adjustment

Controls and instrumentation

- Tower pressure gauges
- Tower status lights
- Switching failure alarm
- Purge flow indicator (KED only)
- NEMA 4 electrical enclosure
- RS232 comm port

ASME stamped pressure vessels

- Fabricated per Section VIII of the boiler and pressure vessel code

Long life non-lubricated inlet and purge control valves standard

Kaeser Heated Purge Dryers (KED) (Table 4)

KED Model Number	Inlet flow @ 100 psig 100°F (scfm)	Purge Flow Rate (scfm)	Air Available Average (scfm)	Heater		Dimensions W x D x H (in.)	Approx. Weight (lb.)	In/Out Connection (in.)	Pre-filter (KOR Series) (scfm)	High-Temp After-filter (HTA Series) (scfm)	Total Replacement Desiccant (lb.)
				(nom kW)	(Avg kW)						
300	300	21	279	5	2.0	50 x 46 x 98	1570	1.5 NPT	375	400	420
400	400	28	372	7	2.7	55 x 52 x 104	2130		625	600	708
500	500	35	465	7	3.3	55 x 52 x 105	2130	2 NPT	625		
600	600	42	558	8	4.0	57 x 53 x 108	2431		780		
750	750	53	697	10	5.0	62 x 59 x 114	2913	3 FLG	1000P	1200	1180
900	900	63	837	12	6.0	62 x 59 x 114	2913		1250P	1800	1420
1050	1050	74	976	14	7.0	66 x 62 x 113	3526		1875P		1848
1300	1300	91	1209	17	8.7	68 x 63 x 118	4250				2500P
1500	1500	105	1395	19	10.0	82 x 66 x 119	6353		4 FLG	3125P	
1800	1800	126	1674	23	12.0	82 x 66 x 119	6353	5000P		4800	4754
2200	2200	154	2046	28	14.7	85 x 73 x 127	9620				
2600	2600	182	2418	33	17.4	85 x 73 x 127	9620				
3200	3200	224	2976	40	21.4	97 x 82 x 125	11,340				

Average Heater kW (fixed cycle) = [kW required to produce 280°F temperature rise] x [235 min. max heat time] / [240 min. drying time]
 Actual kW is less and proportional to the average water load presented to the dryer.

Kaeser Blower Purge Dryers (KBD) (Table 5)

KBD Model Number	Inlet flow @ 100 psig 100°F (scfm)	Blower Flow Rate (scfm)	Blower		Heater		Dimensions W x D x H (in.)	Approx. Weight (lb.)	In/Out Connection (in.)	Pre-filter (KOR Series) (scfm)	High-Temp After-filter (HTA Series) (scfm)	Total Replacement Desiccant (lb.)
			(nom hp)	(Avg kW)	(nom kW)	(Avg kW)						
500	500	94	2.5	1.6	10	6.4	55 x 59 x 105	2215	2 NPT	625	600	708
600	600	113	4	2.5	12	7.7	57 x 60 x 108	2537		780	906	
750	750	140		2.2	14	9.6	62 x 68 x 114	3019	1000P	1200		1180
900	900	158	2.0	17	10.8	62 x 68 x 114	3035					
1050	1050	183	5	2.6	19	12.5	66 x 72 x 113	3676	3 FLG	1250P	1420	
1300	1300	227	7.5	4.9	23	15.5	68 x 73 x 118	4500		1875P	1800	2518
1500	1500	281	10	7.8	28	19.3	82 x 79 x 119	6618				
1800	1800	317		7.3	33	21.7	82 x 79 x 119	6618	4 FLG	2500P	2400	3734
2200	2200	403	5.9	40	27.6	85 x 86 x 127	9885	3125P		3000		
2600	2600	449	15	9.8	45	30.7	85 x 89 x 127	9990	4/6 FLG*	5000P	4800	4754
3200	3200	552	5	2.4	54	37.7	97 x 107 x 127	11,620				
3600	3600	614	7.5	3.1	60	42.0	97 x 116 x 133	14,706	6 FLG	4800	5222	
4300	4300	732		4.2	70	50.1	109 x 123 x 132	16,789				7088

Average Heater kW (fixed cycle) = [kW required to produce 280°F temperature rise] x [235 min. max heat time] / [240 min drying time]

Average Blower kW (fixed cycle) = [Blower kW] x [235 min. max heat time] / [240 min dryer time]

Average Dryer kW (fixed cycle) = [Average Heater kW] + [Average Blower kW]

Actual kW is less and proportional to the average water load presented to the dryer.

*KBD 3200 has a 4" FLG inlet and 6" FLG outlet connection.

Inlet Flow

Inlet Flow capacities shown in the Specifications Table have been established at an inlet pressure of 100 psig (7 bar) and a saturated inlet temperature of 100°F (38°C). To determine maximum inlet flow at other conditions, multiply the inlet flow from the Specifications Table by the multiplier from Table 6 that corresponds to your operating conditions.

KED/KBD Inlet Conditions Correction Factors (Table 6)

Pressure psig (bar/cm ²)	Inlet Temperature °F (°C)						
	60 (15.6)	70 (21.1)	80 (26.7)	90 (32.2)	100 (37.8)	110 (43.3)	120 (48.9)
60 (4.2)	1.03	1.01	0.99	0.80	0.58	0.43	0.32
70 (4.9)	1.10	1.08	1.07	0.94	0.68	0.50	0.37
80 (5.6)	1.17	1.15	1.14	1.08	0.79	0.58	0.43
90 (6.3)	1.24	1.22	1.20	1.18	0.89	0.66	0.49
100 (7.0)	1.30	1.28	1.26	1.24	1.00	0.74	0.55
110 (7.0)	1.36	1.34	1.32	1.30	1.11	0.82	0.61
120 (8.4)	1.42	1.40	1.38	1.36	1.22	0.90	0.67
130 (9.1)	1.48	1.46	1.44	1.42	1.33	0.99	0.74
140 (9.8)	1.53	1.51	1.49	1.47	1.44	1.07	0.80
150 (10.6)	1.58	1.56	1.54	1.52	1.50	1.16	0.87

Specifications are subject to change without notice.

Important:

For inlet temperatures above 100°F, we **strongly** recommend installing a trim cooler. Please note that for every 20°F inlet temperature increase, moisture load/dryer size approximately doubles.

Controls and Instrumentation

Heatless Desiccant Dryers

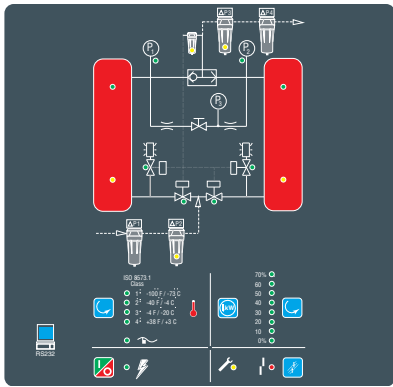

Standard Control (KAD)

The standard controller, with process flow schematic and LED's, makes status checks of control sequence, valves, and filters simple and allows the user to program reminders for routine maintenance intervals. A diagnostic mode steps through the dryer's operational sequence to verify proper function and performance. The display clearly notifies the user if a malfunction occurs.

This controller has four fixed cycle operating modes corresponding to four of the ISO 8573.1 air quality classes for moisture content. In addition, the standard controller includes a manually selectable purge saving feature. The Purge Economizer Switches allow the user to reduce purge consumption in increments of 10% of full purge requirement and down to 30% of dryer capacity, to closely match a constant, fixed load.



Purge Saver Control (KAD PS)

To precisely and automatically match purge air consumption to a changing load, Kaeser offers the Purge Saver Control. Having the same features as the Standard Control (except the Purge Economizer Switches), the Purge Saver monitors temperature changes within the desiccant bed when the dryer is operating at less than its full capacity and keeps the towers on-line until the full drying capacity is reached. This reduces the number of purge cycles and ensures that only the necessary volume of purge air is consumed.

In the event of a malfunction with the Purge Saver Control, standard fixed cycle operation is automatically initiated. Dryer operating status is displayed on a two-line vacuum fluorescent text display with choice of three languages: English, Spanish, or French.

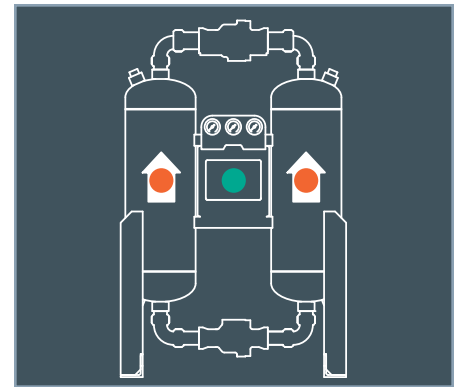

Basic Timer Control (KAD E)

The Basic Timer Control is a reliable fixed cycle timer with LED's indicating which tower is drying. This controller maintains a fixed 10-minute cycle delivering an ISO Class 2 pressure dew point (-40°F). Choose this controller when air demand is uniform and closely matches dryer capacity.

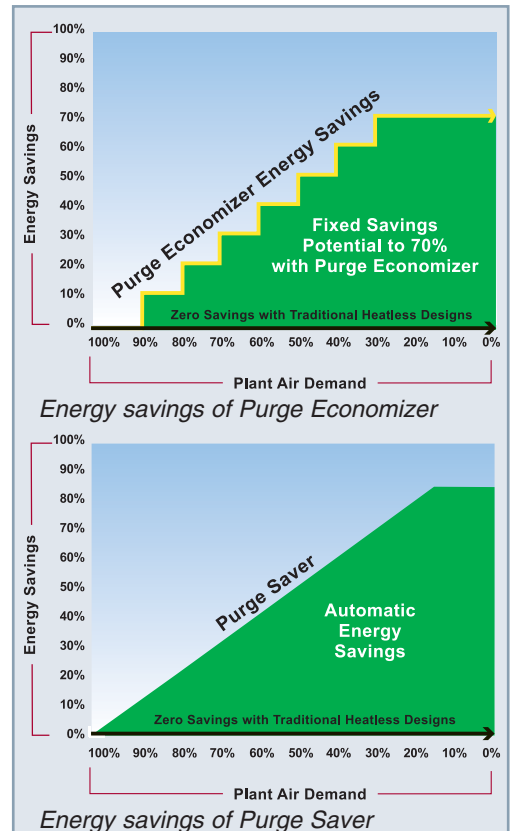

Externally Heated Desiccant Dryers

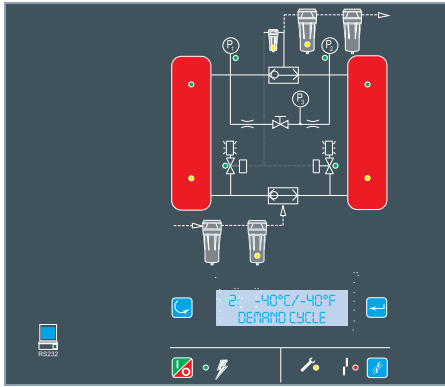

Standard Control (KED and KBD)

The standard controller for heated dryers operates the dryer on a fixed eight-hour cycle. A tower is on-line (drying compressed air) for four hours and then taken off-line to be regenerated during the remaining four hours. Heater operation is terminated when temperature sensors detect that desiccant bed heating is complete. The standard controller's process flow schematic and LED's make status checks of control sequence, valves, and filters simple and allow the user to program reminders for routine maintenance intervals. A diagnostic mode steps through the dryer's operational sequence to verify proper function and performance. The display clearly notifies the user if a malfunction occurs. Dryer operating status is displayed on a two-line vacuum fluorescent text display with choice of three languages: English, Spanish, or French.

Energy Management Control (KED and KBD)

The Energy Management Control for heated dryers monitors the moisture level in the desiccant bed and keeps a tower on-line drying compressed air until the desiccant's adsorptive capacity has been fully utilized. Regeneration is then initiated and completed in the following four hours. The regenerated tower repressurizes then sits idle until the Energy Management Control detects full use of the adsorptive capacity of the drying tower and brings the regenerated tower back on-line. For operation at less than full capacity, the Energy Management Control will match power requirement to demand by reducing the frequency of regeneration. Heater operation is terminated when temperature sensors detect that desiccant bed heating is complete. The standard controller's process flow schematic and LED's make status checks of control sequence, valves and filters simple, and allow the user to program reminders for routine maintenance intervals. A diagnostic mode steps through the dryer's operational sequence to verify proper function and performance. The display clearly notifies the user if a malfunction occurs. Dryer operating status is displayed on a two-line vacuum fluorescent text display with choice of three languages: English, Spanish, or French.

Optional Controls

Heated Purge (KED)

Purge Booster

Without increasing the use of compressed air, purge flow can be increased from 7% to 12% with the optional Purge Booster. This device reduces compressed air consumption from 7% to 6% and draws in an equal volume of ambient air mixing it with the purge air. The increased purge airflow produces lower outlet dew points and minimizes dew point spikes.



Heated Purge and Blower Purge (KED and KBD)

Energy Saver

The Energy Saver Option integrates moisture and temperature sensors to monitor the humidity level near the outlet end of the desiccant beds. During periods of reduced flow, the Energy Saver extends the drying cycle thereby reducing the number of regeneration cycles, saving energy. For KED models, the Energy Saver Option also includes the Purge Booster.

Energy Management

The Energy Management Option includes the Energy Saver Option above and a digital dew point monitor. This feature displays the dryer's outlet dew point and allows the user to prevent tower changeover until a user specified outlet dew point has been achieved, or lets the Energy Management determine the length of the drying period. For KED models, the Energy Management Option also includes the Purge Booster.

Hybritec Combination Dryer

This innovative drying solution combines the energy savings of a refrigerated dryer with the low dew points of a desiccant dryer. Hybritec units operate on a simple premise: air is first treated by a refrigerated dryer to remove most of the air's water vapor. Then a blower purge desiccant dryer further reduces the dew point. Finally, the air is returned to the refrigerated dryer to be reheated before use.

The advantages over other dryer types are a more consistent outlet dew point and greatly reduced operating costs. Hybritec dryers produce both refrigerated dew points of +38°F and desiccant dew points of -40°F. For larger applications, high energy cost areas, or if your need for low dew points is seasonal, the Hybritec is a superior solution that will pay back quickly. See our separate brochure (USHYBRITEC) for details and contact us for an operating cost comparison.

Sizes from 700 to 5300 scfm



Total cost of purchase, operation, and maintenance of desiccant dryers

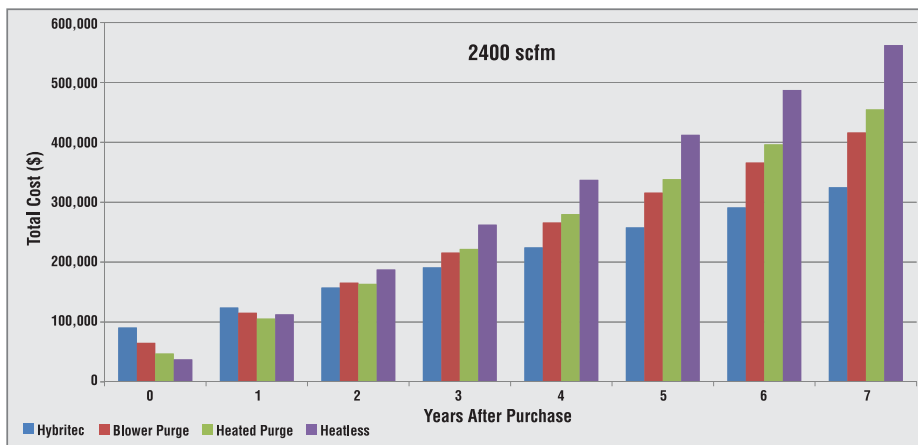

For 2400 cfm, Hybritec's total costs, including purchase are lower than other types of desiccant dryers after only 2 years. For 5300 cfm, Hybritec breaks even with other dryers in less than a year. Based on 8760 hours of operation at \$0.10/kWh running desiccant dryer 7 months.

Superior drying performance

The Hybritec dryer produces a consistent outlet dew point and air temperature. There are no spikes at any time during the drying or regeneration cycle. The hybrid system achieves the following ISO 8573.1 classes:

- Class 2 for moisture
- Class 2 for solids/particulate
- Class 2 for oil

Higher tolerance to high temperatures

Hybritec dryers significantly outperform other heated desiccant dryers, especially when inlet temperatures are above rated conditions. For example, increasing inlet air temperature just 5° from 100°F to 105°F results in a 13% decrease in capacity of other heated desiccant dryers. With a 10°F rise, other dryers lose 26% of their rated capacity. The Hybritec's refrigerated dryer greatly reduces the impact of inlet temperature on capacity.

Energy cost advantages:

At rated conditions and producing a -40°F dew point for seven months per year and a 38°F dew point for the remaining five months, a Hybritec system consumes:

- 48% less power than a blower purge dryer.
- 54% less power than a heated purge dryer.
- 64% less power than a heatless dryer.

Options



Insulation for heated desiccant air dryers (KED and KBD)

Insulation with protective jacket for heater and heater discharge piping is standard; however, insulation for the desiccant vessels is optional. Vessel insulation offers protection for personnel and reduces operating costs. Vessel insulation is flexible open-cell melamine foam having a permanently bonded PVC film laminated polyester fabric jacket. This insulating system absorbs impact and returns to its original shape, thus maintaining its insulating qualities.

Other options

- High humidity alarm
- Dew point monitor
- Stainless steel or copper pilot and instrument air tubing and fittings
- NEMA 4 low ambient protection packages
- NEMA 7 Explosion-proof electrical packages (KAD only)
- Parallel piped pre-filters and after-filters



Wall-mounted heatless desiccant air dryers (KADW)

Compact and convenient, these wall-mounted dryers are available in seven models from 7 to 50 scfm all with factory supplied filter packages. Four minute fixed cycle timer produces standard -40°F pressure dew point at rated flow conditions. Lower pressure dew points, to -100°F, are achieved by reducing air flow rate.

Filtration



All desiccant dryers require proper filtration. Coalescing pre-filters prevent contamination of desiccant beds by hydrophobic aerosols. Particulate after-filters collect traces of desiccant dust that may exit the dryer. Maintaining these filters extends service intervals and provides excellent air quality. All Kaeser desiccant dryers offer optional filter packages with or without block and bypass valves.



KAESER COMPRESSORS

Built for a lifetime.™

The Air Systems Specialist

We earn our customers' business by supplying superior quality equipment and services. Our products are designed for reliable performance, easy maintenance, and energy efficiency. Prompt and dependable customer service, quality assurance, training, and engineering support contribute to the value our customers have come to expect from Kaeser. Our employees are committed to implementing and maintaining the highest standards of quality to merit customer satisfaction. We aim for excellence in everything we do.

Our engineers continue to refine manufacturing techniques and take full advantage of the newest machining innovations. Extensive commitment to research and development keeps our products on the leading edge of technology to benefit our customers. Our industry-leading controls continue to set the standard for efficient system operation. With over 90 years of experience, Kaeser is the air systems specialist.



Kaeser Compressors, Inc.

511 Sigma Drive
Fredericksburg, Virginia 22408 USA
Phone: 540-898-5500
Toll Free: 800-777-7873
Email: info.usa@kaeser.com

Certified Management Systems



Kaeser Compressors Canada Inc.

3760 La Verendrye Street
Boisbriand, QC J7H 1R5 CANADA
Telephone: (450) 971-1414
Toll free: (800) 477-1416
info.canada@kaeser.com

Kaeser Compresores de México S de RL de CV

Calle 2 #123
Parque Industrial Juríca
76100 Querétaro, Qro.
Telephone: 01 (442) 218 64 48
sales.mexico@kaeser.com

Kaeser Compresores de Guatemala y Cia. Ltda.

Calz. Atanasio Tzul 21-00, zona 12
El Cortijo II, Bodega 501
01012-Guatemala City
Telephone: +502 2412-6000
info.guatemala@kaeser.com