

**KAESER**  
**COMPRESSORS**

*Built for a lifetime.™*



# Oil-free Screw Compressors

## CSG-2, DSG-2, and FSG-2 Series

Capacities from: 192 to 1774 cfm

Pressures from: 45 to 145 psig

[kaeser.com](http://kaeser.com)

# Oil-free Rotary Screw Compressors

## The new dimension in oil-free compression

*With logical component layout and exceptional attention to detail, Kaeser's 2-stage oil-free air compressors were designed specifically with the user in mind. Kaeser's renowned quality offers peace of mind and built for a lifetime™ reliability.*

### Long-term efficiency

Compressed air simply has to be available where and whenever it's needed. Kaeser's 2-stage oil-free rotary screw compressors are built to last and ensure many years of dependable performance. With nearly a century of experience in engineering, Kaeser's components are tried and tested to deliver the durability and compressed air availability needed to meet the toughest demands.

### Innovation you can trust

Using all of the advantages that Kaeser's advanced Research and Development Center in Coburg, Germany has to offer, Kaeser's engineers have designed every detail of these oil-free air compressors with maximum efficiency and performance in mind.

### Efficiency as standard

Kaeser quality and expertise really count when it comes to the all-important total system costs for asset investments such as compressors, or complete compressed air supply systems. Lowest possible compressed air costs and maximum availability can be guaranteed only through a combination of perfect interplay between energy efficiency and service / maintenance, and by viewing the compressed air supply system as a whole.

### Service-friendly

These versatile systems were engineered for maximum ease-of-use and servicing right from the outset of the design stage. Fewer wearing parts and using premium quality materials ensure reduced maintenance requirements, longer service intervals, and extended service life. Excellent component accessibility as a result of generously sized maintenance doors and a swing-out cooler are just some of the features that make servicing these units so effortless.

### Energy efficiency

Capital and maintenance costs account for only a small part of a compressor's total life cycle costs. Since energy accounts for the largest portion, it's wise to save with Kaeser's Life Cycle Management. Kaeser has been committed to minimizing your energy costs for compressed air production for over 40 years. We also have the bigger picture in mind when it comes to service and maintenance as well as maximum compressed air supply availability.

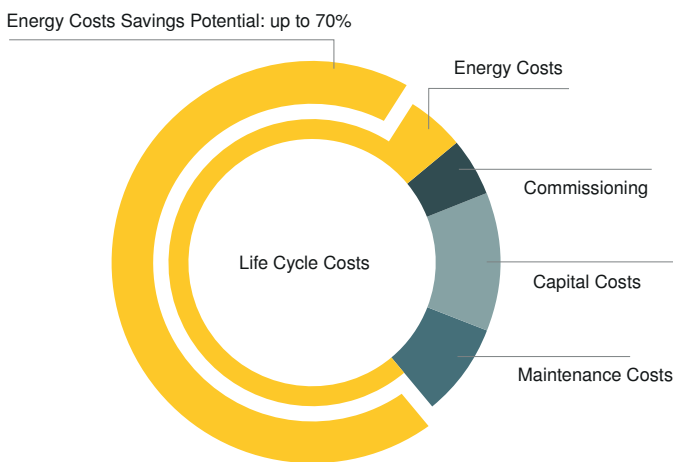

# Kaeser airends: Precise, durable, efficient



## Proven airends

At the heart of every Kaeser oil-free compressor lies a rugged, two-stage rotary screw airend proven to withstand the toughest operation. Providing optimum performance and dependability, every airend ensures maximum efficiency throughout its entire service life.



## Durable coating

The blasted and bonderized rotors are treated using a special coating process which provides an innovative and durable coating resistant to temperatures up to 575°F. Because this coating is highly abrasion-proof, its sealing and protection performance remain consistent — even after years of operation — providing additional cost savings.



## Chromium steel rotors

The second compression stage's rotors are made from stainless steel, which eliminates the risk of rotor corrosion and seizing.

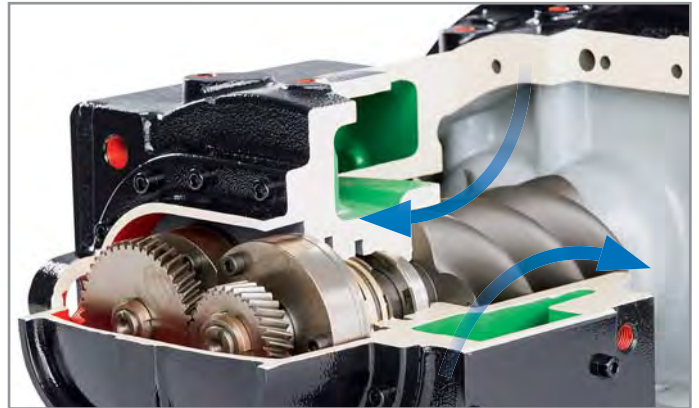

## Jacket-cooled airend

Jacket cooling is used in the high pressure compression stage of the airend to ensure optimal heat dissipation, which greatly enhances efficiency.

# Efficient drive systems with advanced control



## Sigma Control 2™

The onboard controller ensures efficient control and compressor operation monitoring. The large display and RFID reader provide easy communication and maximum security. Multiple, selectable interfaces enable seamless networking capability, while the SD card slot makes updates quick and easy.

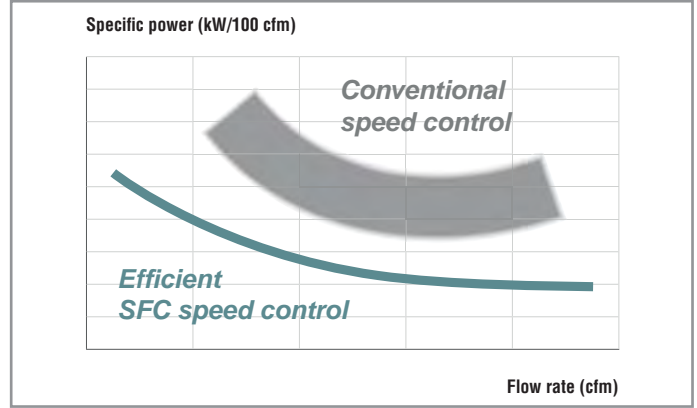

## Optimized specific power

Together, the moderate maximum speed and near-constant specific power across the wide variable speed control range, achieve significant energy savings throughout the entire operating curve.



## Premium efficiency drive motors

Kaeser uses premium efficiency Totally Enclosed Fan Cooled (TEFC) motors with class F insulation for extra protection from heat and contaminants. Each of the three motor windings is actively monitored through its own PT100 temperature sensor. Standard voltages are 460 or 575 V (3-phase, 60 Hz). Other voltages are available.



## Sigma Air Manager 4.0

This advanced master control system can coordinate operation of up to 16 rotary screw compressors with maximum energy efficiency and also enables seamless documentation of all operational parameters.

# Service-friendly



## (1) Hydraulic inlet valve

The hydraulically operated inlet valve on Kaeser oil-free rotary compressors is unaffected by contamination and condensate. This makes the valve more reliable and easier to maintain than pneumatic styles.



## (2) Fiber-free pulsation dampeners

Kaeser's fiber-free pulsation dampeners keep pressure losses to an absolute minimum, help maintain consistent air quality, and minimize unwanted vibration. In addition, their fiber-free design reliably eliminates the possibility of compressed air contamination.





### (3) Easy access coupling

The electric motor directly drives the airend with zero transmission losses via a maintenance-free coupling. As there is no need for complicated disassembly or alignment work, the easy-access coupling can be exchanged quickly and easily.

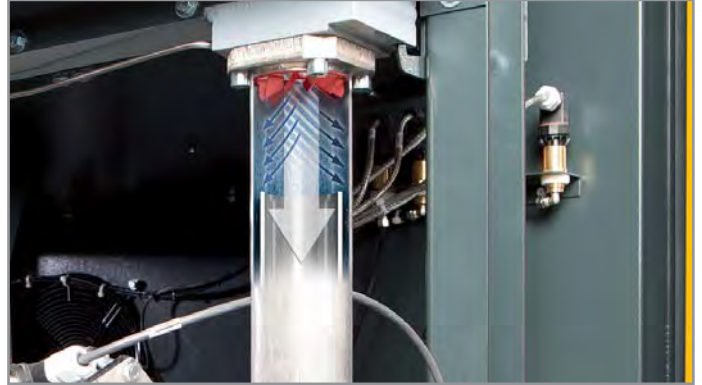

### (4) High efficiency condensate separator

Thanks to its flow-optimized design, the newly developed condensate separator reliably separates the condensate downstream of the aircoolers—with minimal pressure loss.

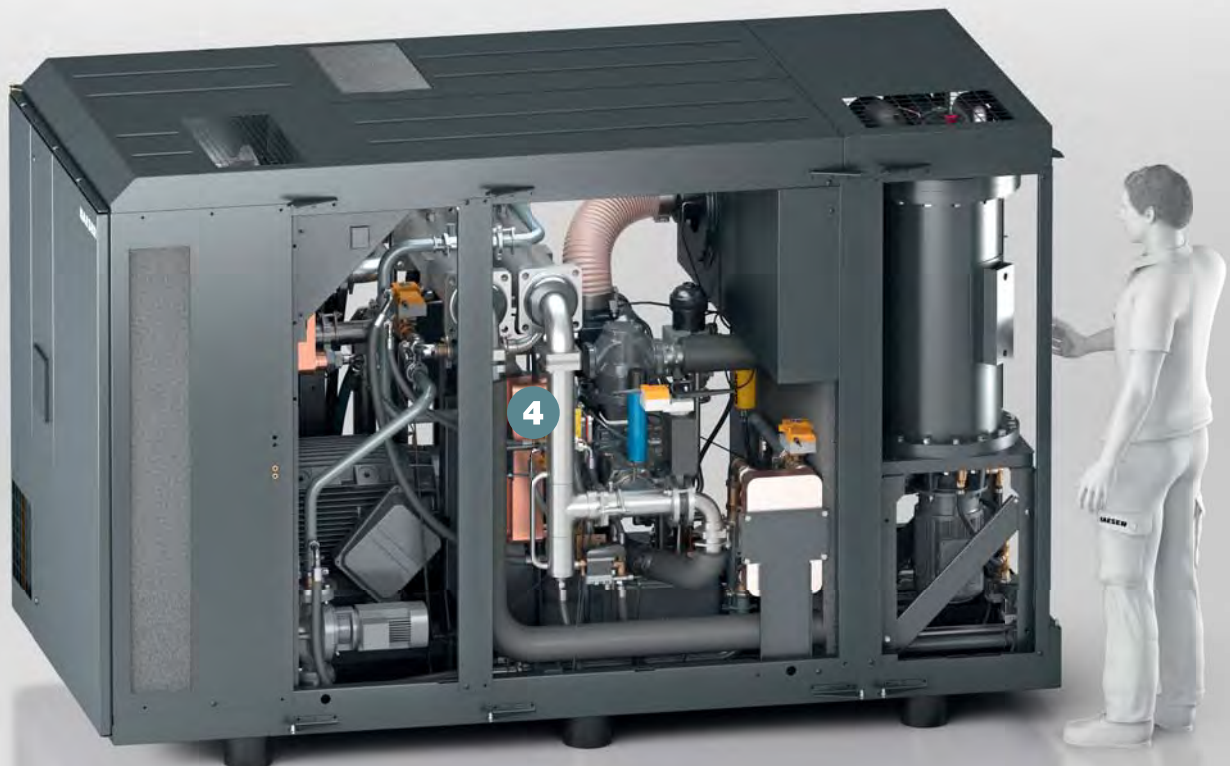

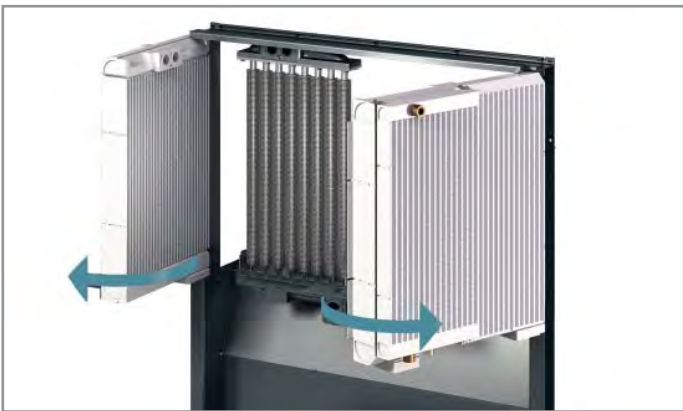
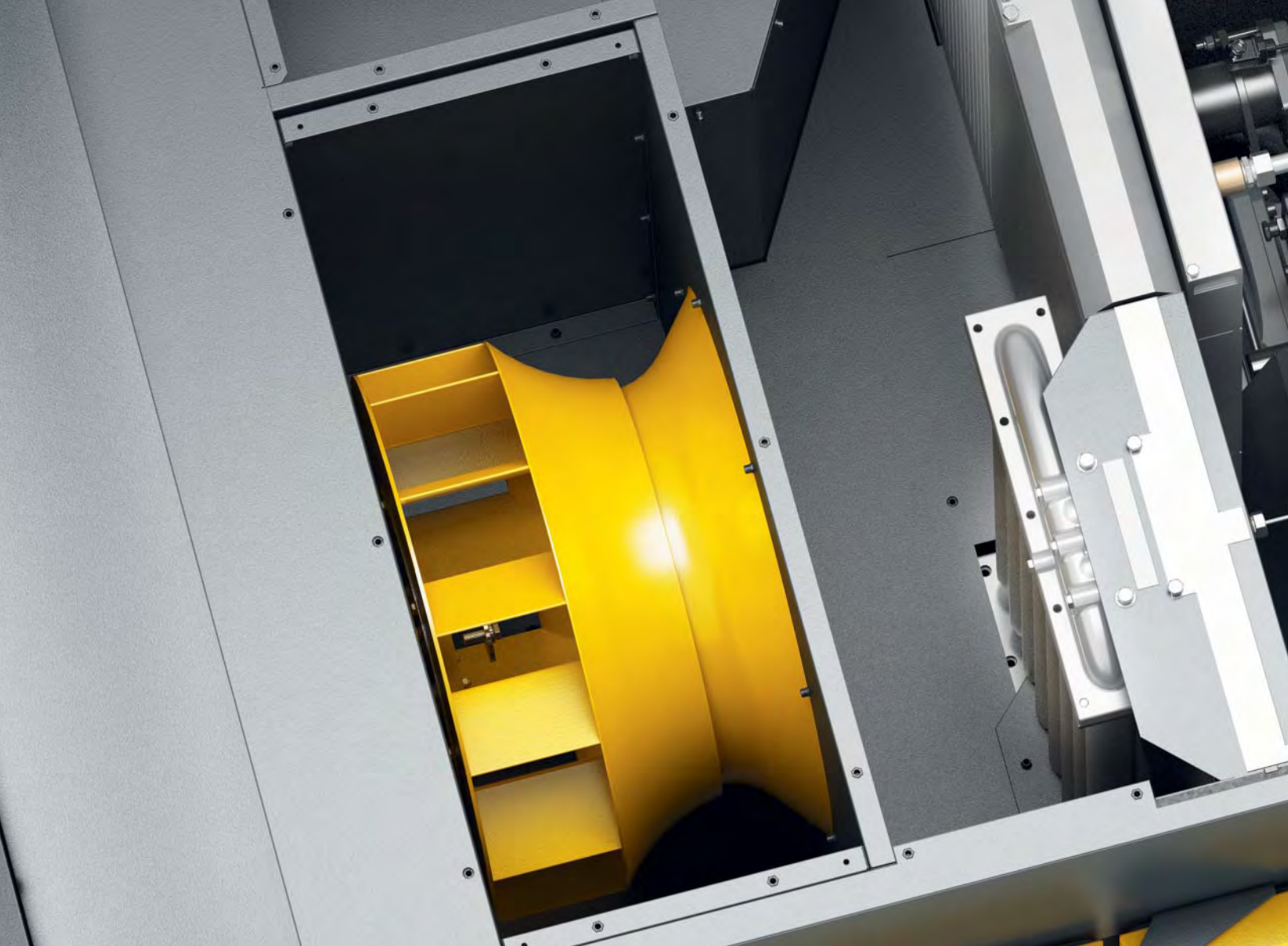

### Cleaning made simple

Cleaning the aircoolers on DSG-2 and FSG-2 models is convenient and easy thanks to our unique swing-out design—no crane is needed. Service technicians can clean the coolers in considerably less time and right next to the machine, without the risk of contaminating the unit's interior.



### Reliable operation even in extreme heat

Air-cooled units can operate dependably in ambient temperatures up to 115°F thanks to the durable and energy-efficient radial fan.

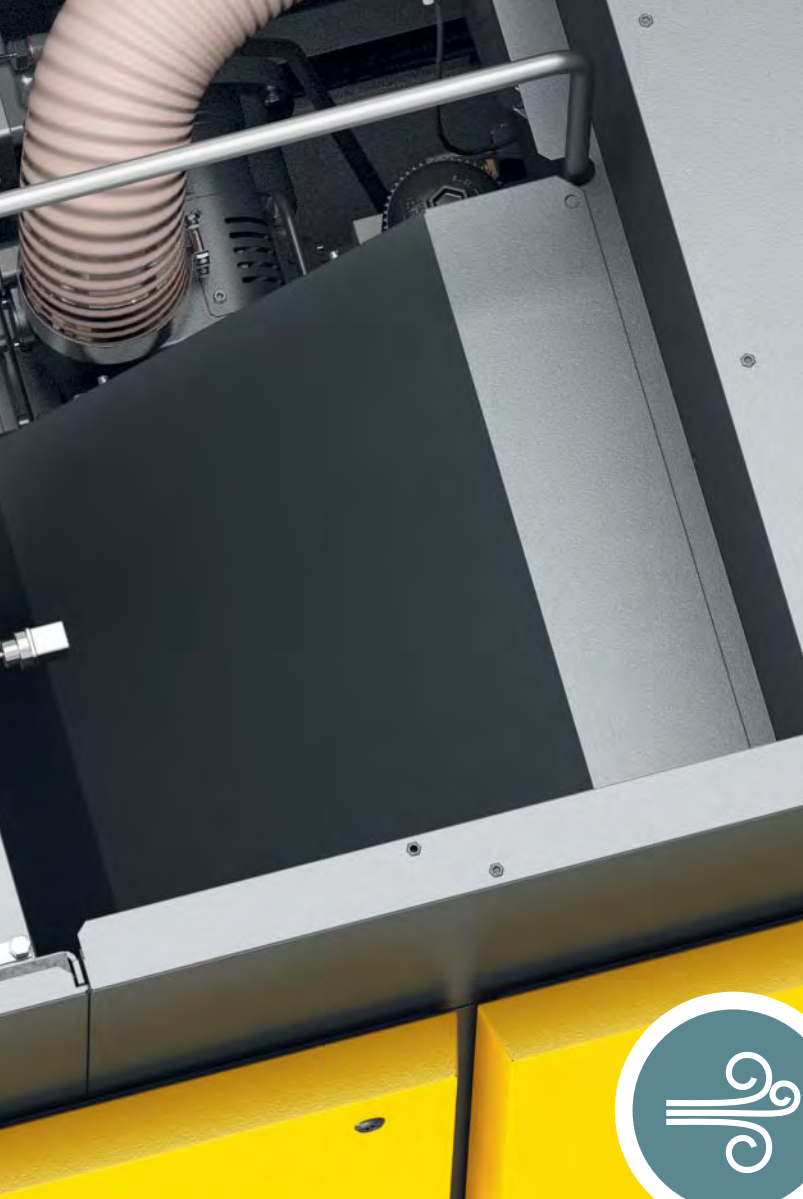

# Air-cooling

## Dependable performance— Even under extreme conditions

### The benefits:

- Cooling water infrastructure not needed
- Meticulously designed machines with logical component layout make maintenance and service work quick and easy, ensuring further savings
- The heated cooling air can be easily re-used for space-heating



### Outstanding durability thanks to pre-cooling

Highly effective pre-cooling with a stainless steel tube cooler on the high pressure side ensures outstanding air cooler durability. Furthermore, this durable cooler combination also delivers comparably low compressed air discharge temperatures.

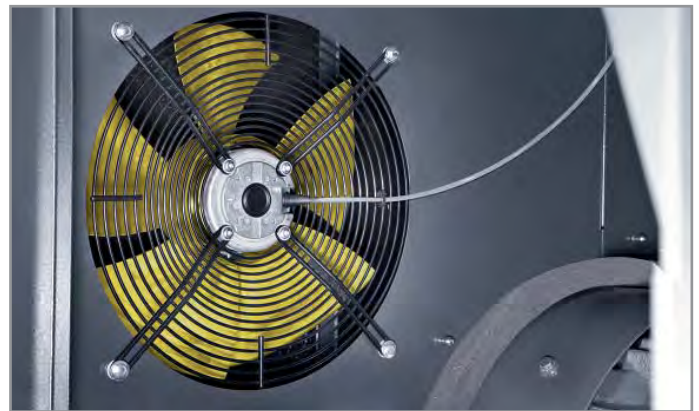

### Energy-saving interior ventilation

When the large radial fan in air-cooled oil-free compressors is switched off as part of the transition to standby mode, this energy-saving, temperature-controlled standstill fan reliably removes the remaining heat in the compressor package.



# Water-cooling

## Compact energy savers

### The benefits:

- Exceptionally low compressed air discharge temperature thanks to separate high quality air coolers
- Load-dependent cooling water for optimum compressor cooling and simultaneous, efficient cooling-water usage
- Compact design

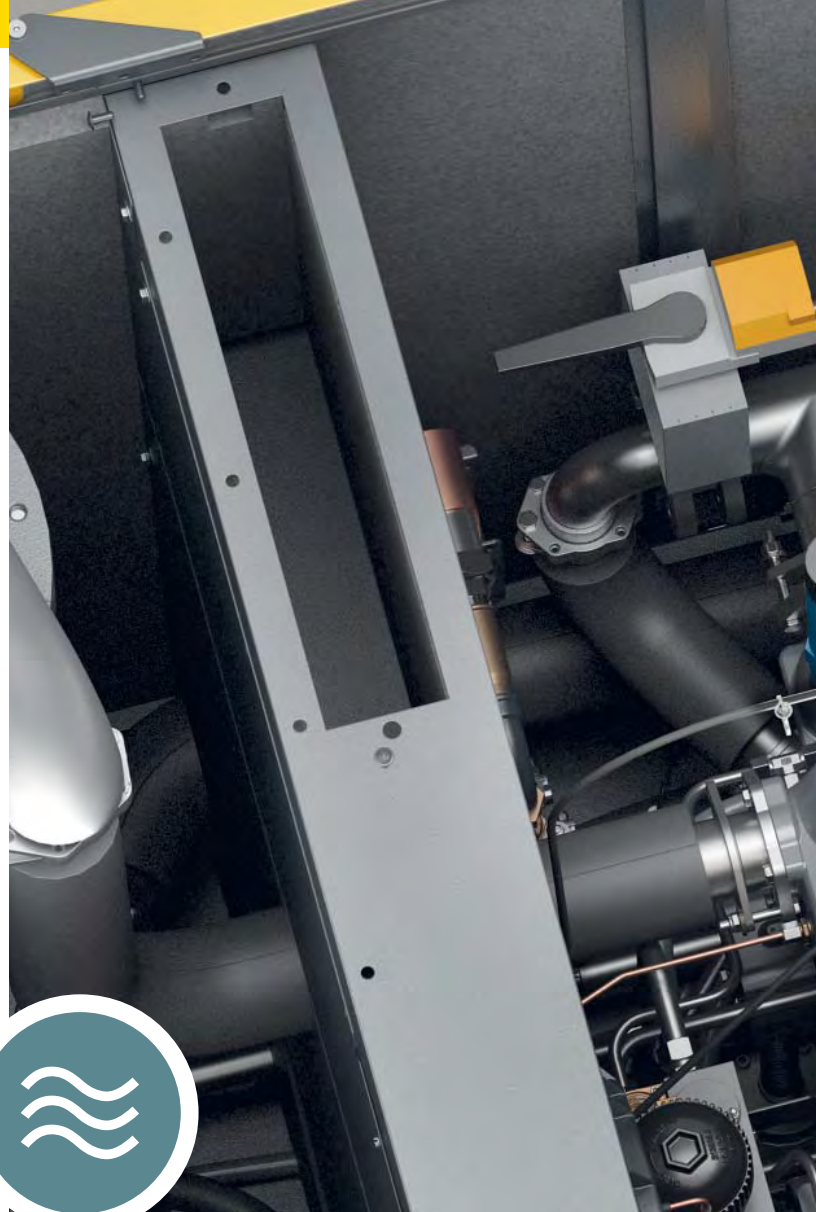

### Parallel heat exchanger

Both the low and high pressure stages of Kaeser's water-cooled oil-free screw compressors are equipped with their own dedicated parallel heat exchanger for enhanced heat transfer. This optimized cooling improves specific power performance.

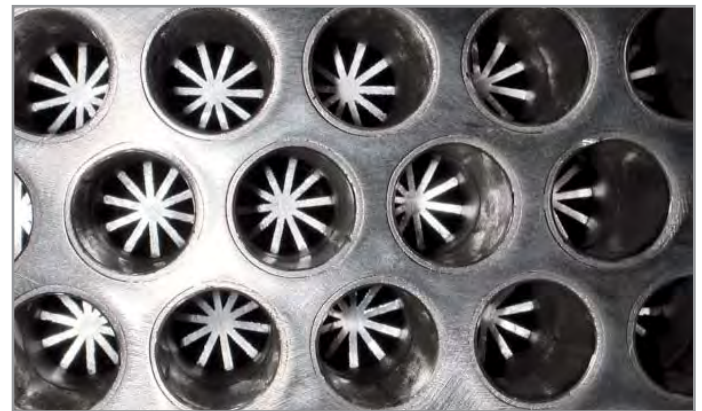

### Optimized water cooler

Water-cooled compressors feature highly efficient air/water heat exchangers. Cupronickel (CuNi10Fe) cooling pipes with internal star lamella fins provide optimum heat transfer and the lowest possible compressed air discharge temperatures with minimal pressure loss.

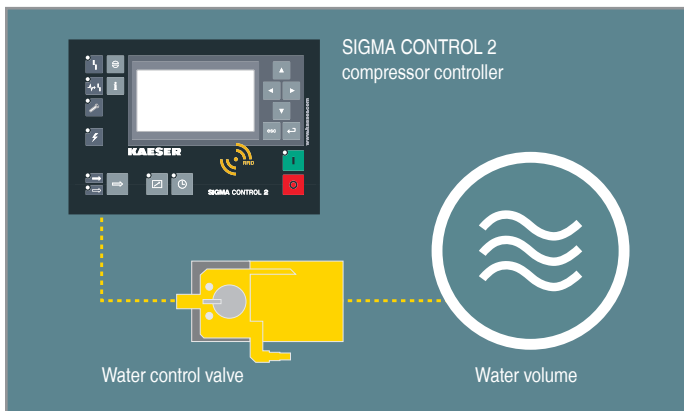
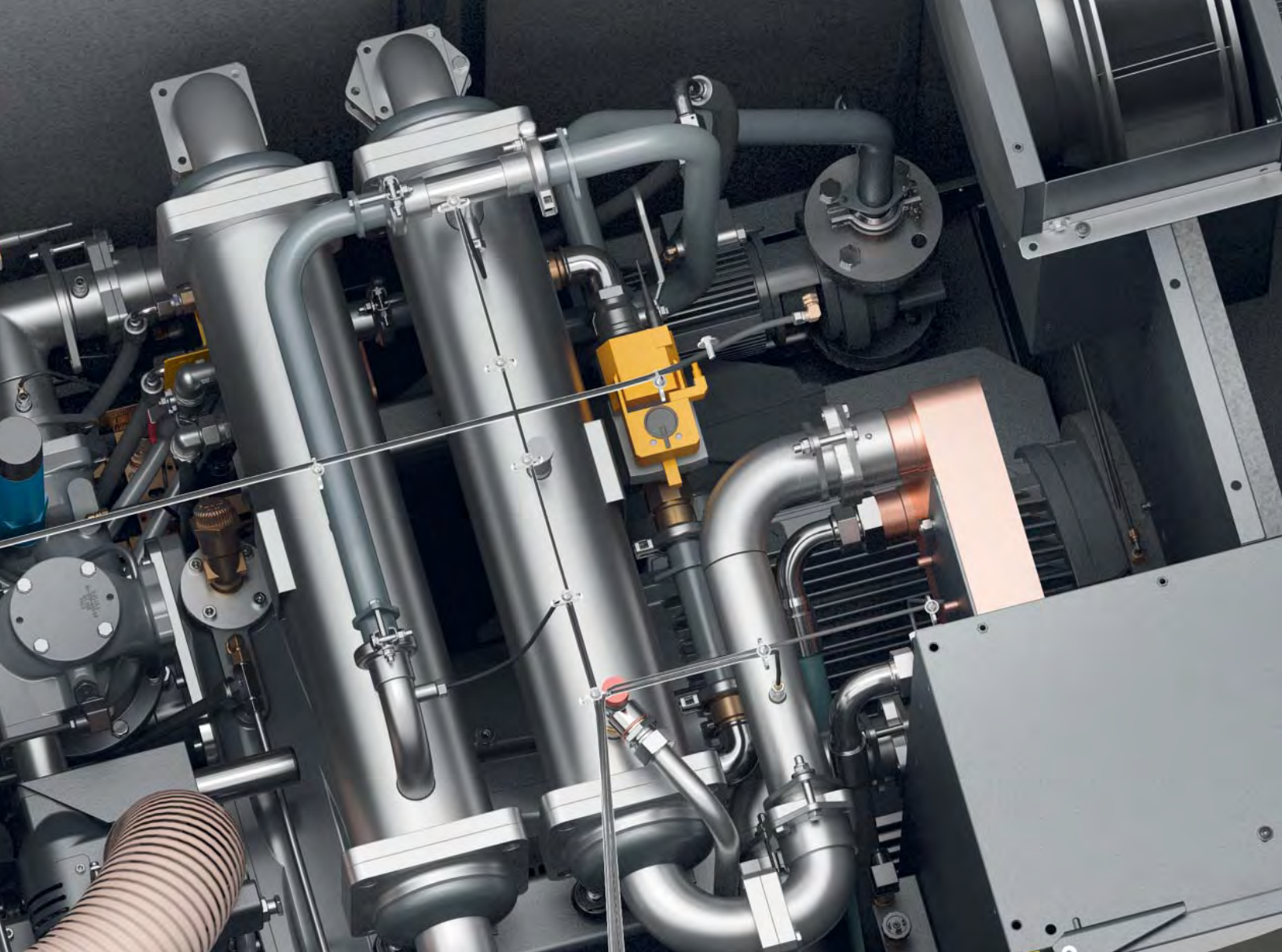

**Smart control**

Water-cooled oil-free compressors feature sealed water control valves that are actuated via the onboard Sigma Control 2. The controller precisely adjusts water volume to meet actual load requirement.

**Permanent adjustment**

The important but time consuming task of performing hydraulic adjustment of both aircoolers is carried out continuously and automatically when the machine is in operation. Cooling performance is therefore optimally matched to the operating conditions.



# Variable frequency drive (SFC)

Kaeser's oil-free screw compressors are available with integrated Sigma Frequency Control (SFC) to provide superior part load efficiency and steady pressure in applications with varying air demands. Standard features include EMI filters and line reactors for extra electrical system protection.

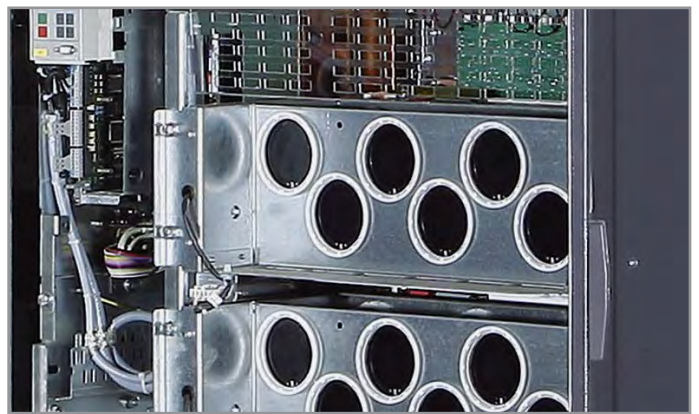

## VFD drive from Siemens

SFC versions feature the latest in Siemens drive technology for enhanced reliability, world-wide support, and easy integration into system controls.



## Safe operation even in hotter environments

A generously-sized SFC module and efficient control cabinet cooling allow Kaeser variable frequency drive compressors to be used in high ambient temperatures.

# Integrated refrigerated dryer

Kaeser's CSG-2 models are available with an optional integrated refrigerated dryer to ensure compressed air drying for the intended application and all flow rates. These high quality industrial machines provide reliable protection from condensate damage — even under the harshest conditions.



## Energy-saving drying

An integrated design, together with the generously-dimensioned aluminum block heat exchanger, keeps pressure loss less than 1.5 psi. The energy-saving scroll refrigeration compressor helps achieve compressed air energy savings.



## Excellent accessibility

All refrigerated dryer components are easily accessible via the service door on the front of the unit, making dryer service and maintenance work a breeze.



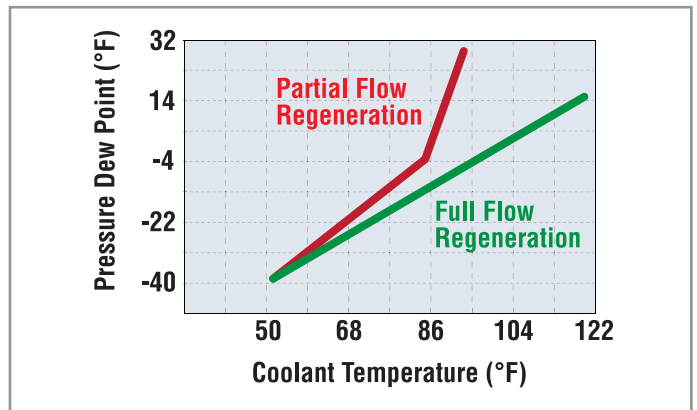
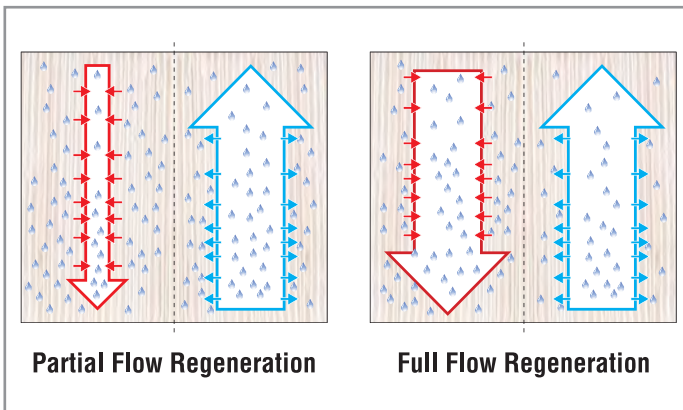

### Full-flow regeneration

The i.HOC (Integrated Heat of Compression Dryer) system uses 100% of the heat of compression from the second compressor stage for drying purposes (full-flow regeneration). This heat is produced and available for use at zero cost.

### Drying even near the limit

The advantages of full flow regeneration become obvious, especially with increased coolant temperatures. Kaeser rotary drum dryers achieve outstanding drying results without additional electric heating for air regeneration.



# Integrated Heat of Compression Dryer (i.HOC)

## Dependable pressure dew point thanks to innovative process engineering

The patented i.HOC rotary drum dryer from Kaeser uses up to 100% of the heat of compression. Thanks to its full-flow regeneration method, these dryers deliver reliable pressure dew points up to an ambient temperature of 115 °F—without electrical heating or additional cooling of the regeneration air. Air-cooled and water-cooled versions for CSG-2 and DSG-2 models are available.

### The benefits:

- Dependable pressure dew points below freezing even with high ambient or coolant temperatures
- Pressure dew point stability even at the lowest compressor load — without the need for a partial load compensator.
- Available with pressure dew point control as required
- Highly effective drying and heat recovery with water-cooled compressors



### Perfect performance

The i.HOC rotary drum dryer's intelligent control ensures dew point stability even with fluctuating flow rates and at compressor partial load. When commissioned, the target pressure dew point is reached after just one rotation of the drum.

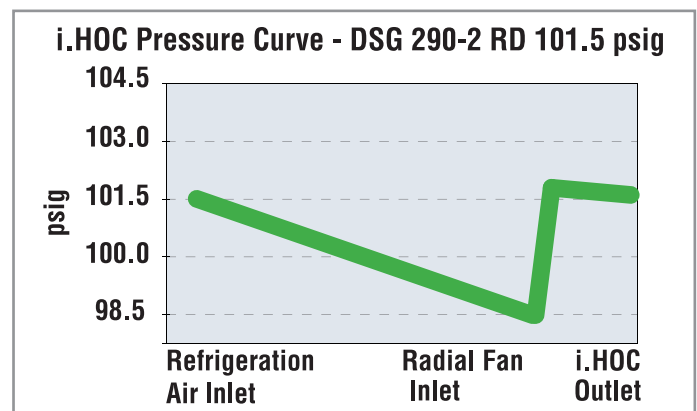

### No pressure loss

The radial fan at the bottom of the dryer equalizes drying process pressure losses as required, thereby guaranteeing maximum pressure dew point stability and quality—the pressure at the i.HOC dryer outlet is higher than at the inlet.

# i.HOC

## Ultra efficiency and low pressure dew points



### Durable, low-dust drum

The silica gel desiccant is embedded in a precisely manufactured drum with plain thrust bearings for exceptionally high run-out qualities. The desiccant has significantly less dust than others, which results in a longer service life for downstream particulate filters. The superior sealing between the desiccant and the regeneration sections reduces pressure dew point fluctuations and increases energy efficiency.



### Variable speed drum motor

The speed of the drum is automatically adjusted to actual compressor performance in order to regenerate the desiccant as effectively as possible. This is the key to ensuring consistently low pressure dew points at varying loads.



### Durable and efficient

Thanks to computational fluid dynamics optimization, the flow-optimized radial fan installed in the base of the dryer efficiently compensates for the pressure losses in the i.HOC cooling path.

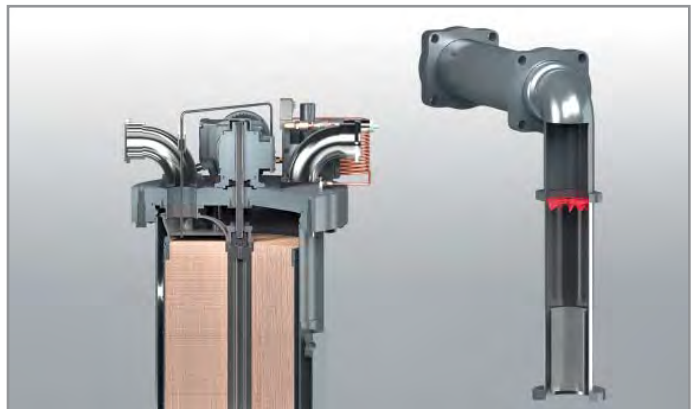

### External condensate separation

i.HOC uses a highly efficient condensate separator downstream of the second stage heat exchanger in order to separate the condensate that precipitates during the regeneration process. Moisture is collected outside of the drum to prevent contamination and increase service life.

# Air treatment options

Depending on the pressure dew point you need, Kaeser offers several options, from traditional refrigerated dryers to heatless desiccant dryers. The i.HOC dryer presents a unique combination of low dew point, space savings, and superb energy efficiency. Contact your local authorized Kaeser representative to discuss your air treatment needs.



+



## Refrigerated dryer

For many oil-free applications, refrigerated dryers are the go-to choice for delivering the best possible energy efficiency and lowest investment cost for dew points down to 38°F. For lower dew points, a desiccant dryer is needed.

## Integrated heat of compression dryer

For dew points as low as -22°F, the optional i.HOC drum dryer is integrated into the package. The hot compressed air from the second compression stage is used to regenerate the desiccant.

38°F

-22°F

## Cost Comparisons

### Annual Energy Costs

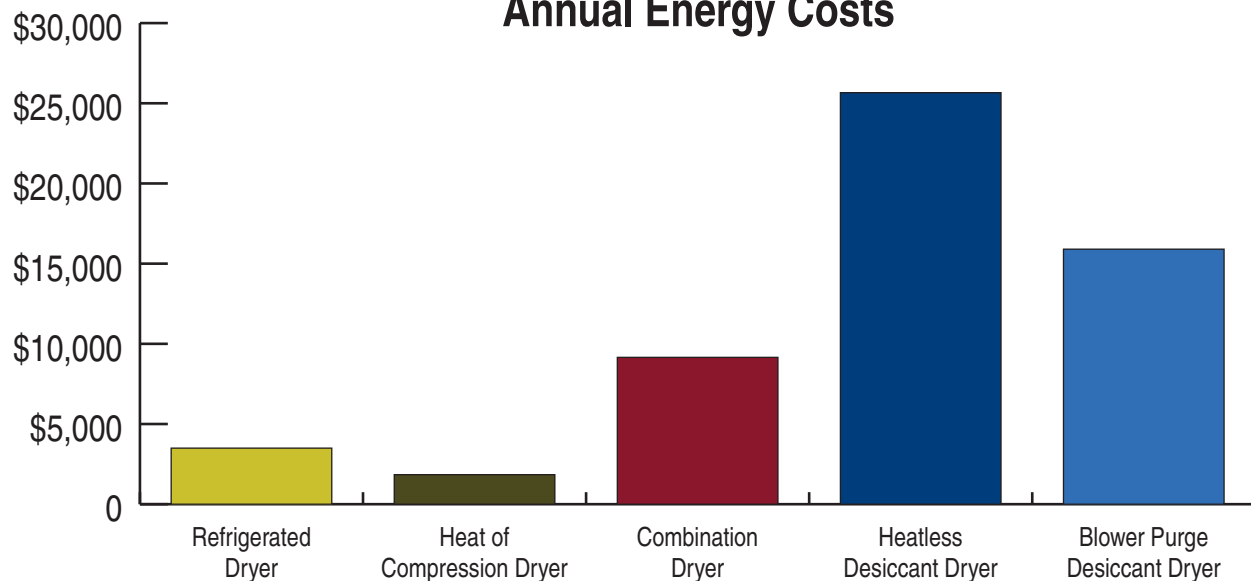

*Based on 8760 hours of operation, maximum ambient temperature 100°F, air pressure at dryer inlet 100 psig, maximum air temperature at dryer inlet 100°F, maximum air flow rate of 1000 scfm, and \$0.10/kWh.*





### Combination dryer

Hybritec dryers combine the energy-saving operation of refrigerated dryers with the ultra-low dew points of blower purge desiccant dryers and are able to achieve dew points as low as -40°F with far less energy than a large blower purge dryer alone. They are ideally suited for large volume applications where the required dew points vary seasonally.

### Heatless desiccant dryer

Kaeser's KAD heatless regenerative dryers use approximately 15% of their dry air output to regenerate the saturated air tower. KADs are initially less expensive than heat reactivated dryers, but they usually have the highest operating costs. KADs produce pressure dew points as low as -100°F at rated conditions.

**-40°F**

**-100°F**

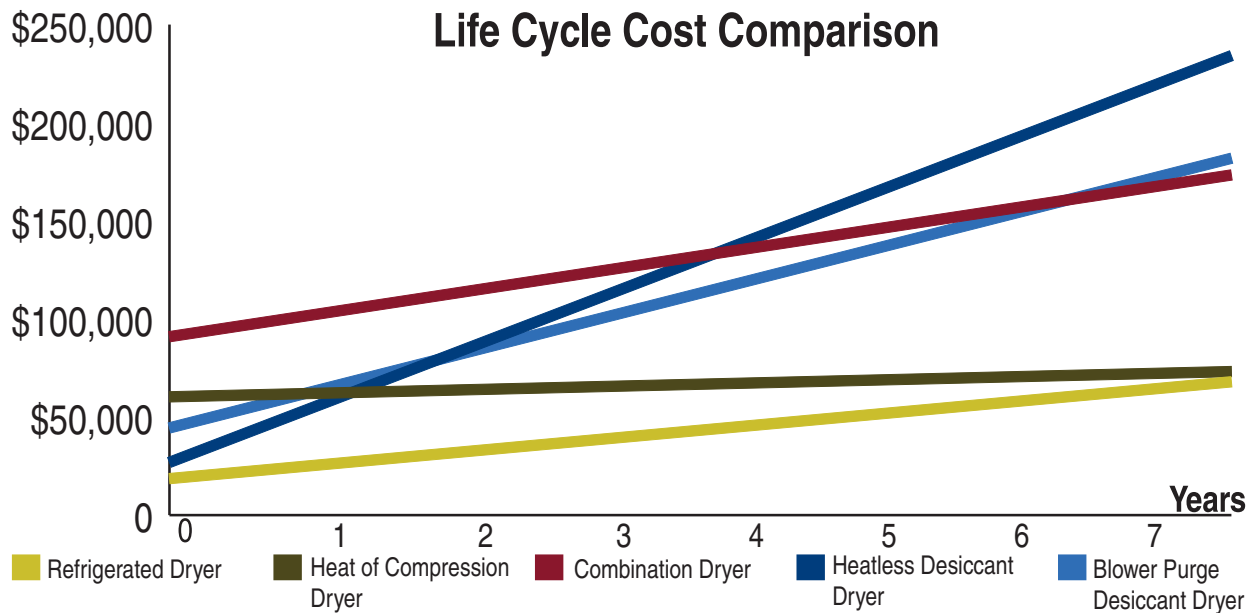

*Based on 8760 hours of operation, maximum ambient temperature 100°F, air pressure at dryer inlet 100 psig, maximum air temperature at dryer inlet 100°F, maximum air flow rate of 1000 scfm, and \$0.10/kWh.*

# Heat recovery

## Air-cooled compressors

Recovering warm compressor exhaust air is an innovative way to seize savings potential. Kaeser has the expertise to help you with everything you need to know and will be with you every step of the way.

## Water-cooled compressors

Using the compact heat recovery module integrated directly into the compressor, generating hot water for production or auxiliary heating purposes couldn't be simpler. Cost and space-intensive external infrastructure is not necessary with Kaeser's solutions and the amortization period of the heat recovery module is usually less than a year (see sample calculation below).



### Example amortization calculation water-cooled compressor

Inlet temperature	68°F
Relative humidity	30%
Cooling water inlet (primary)	68°F
Cooling water outlet (primary)	176°F
Compressor power consumption CSG-130-2 145 psi(g)	130 hp
Heat recovery potential based on total power consumption	87%
Recoverable heat capacity	113 hp
Annual operating hours	6,000 hrs
Kilowatt hours per year	505,296 kWh
Fuel costs	\$0.10 / kWh
Annual fuel cost savings	\$50,530
<b>Amortization period</b>	<b>&lt; 1 year</b>



Up to  
**195 °F**  
hot

**Process, heating, and service water**

Compressor exhaust heat can be used to produce hot water with temperatures up to 195 °F, which can then be used for a wide range of applications.



**Space heating with warm exhaust air**

Heating is made easy thanks to radial fans with high residual thrust. The reusable warm air from air-cooled oil-free screw compressors can be easily ducted away to spaces that require heating—and usually without the need for additional fans.

# Technical Specifications

## SFC Units

Model	Pressure Range <sup>(1)</sup> (psig)	FAD Complete Unit at Max Working Pressure Air-cooled <sup>(2)</sup> (acfm)		Rated Motor Power (hp)	Sound Level (dB(A)) <sup>(3)</sup>	Standard Air-cooled <sup>(4)</sup> Units		Water-cooled Units	
		Min.	Max.			Dimensions L x W x H (in.)	Weight (lb.) <sup>(5)</sup>	Dimensions L x W x H (in.)	Weight (lb.) <sup>(5)</sup>
CSG 90-2 SFC CSG 90-2 T SFC CSG 90-2 RD SFC	60	117	412	75	74		5368		5368
	90	114	369						
	125	125	320						
CSG 120-2 SFC CSG 120-2 T SFC CSG 120-2 RD SFC	60	141	461	100	76	98 x 65½ x 84½	5677	98 x 65¾ x 77¾	5677
	90	161	459						
	125	145	430						
	145	170	400						
CSG 130-2 SFC CSG 130-2 T SFC CSG 130-2 RD SFC	125	182	468	125	76		5952		5952
	145	193	467						
DSG 180-2 SFC DSG 180-2 RD SFC	65	310	795	150	81		9149		8488
	90	332	761						
	125	309	670						
	145	337	615						
DSG 220-2 SFC DSG 220-2 RD SFC	65	278	820	175	81	135¼ x 68¾ x 93¾	9480	135¼ x 68¾ x 81¼	8818
	90	294	820						
	125	319	778						
	145	378	737						
DSG 260-2 SFC DSG 260-2 RD SFC	65	309	967	200	82		9811		9149
	90	330	966						
	125	346	911						
	145	364	858						
DSG 290-2 SFC DSG 290-2 RD SFC	100	384	1059	250	84		10,141		9480
	125	416	1058						
	145	447	1057						
FSG 420-2 SFC	100	555	1525	350	83	162¾ x 81¾ x 107½	15,543	149¼ x 82½ x 91¼	13,999
	125	604	1430						
	145	653	1334						
FSG 500-2 SFC	100	624	1789	450	84		15,873		14,330
	125	663	1710						
	145	702	1612						

### NOTES:

(1) Other pressures available from 45 to 145 psig. (2) Performance rated in accordance with CAGI/ISO 1217 test code. (3) Per ISO 2151 using ISO 9614-2.

(4) Dimensional drawings for air-cooled and water-cooled units as well as "T" and RD models are available on request from your local authorized Kaeser distributor.

(5) Weights may vary slightly depending on airend model.

460 or 575 V, 3 ph, 60 Hz; other voltages available. Compressors are available water-cooled with stainless steel, plate type heat exchangers as standard equipment.

Shell and tube heat exchangers are available on request.

**Specifications are subject to change without notice.**

# Fixed Speed Units

Model	Pressure Range <sup>(1)</sup> (psig)	FAD Complete Unit at Max Working Pressure Air-cooled (acfm) <sup>(2)</sup>	Rated Motor Power (hp)	Sound Level (dB(A)) <sup>(3)</sup>	Standard Air-cooled <sup>(4)</sup> Units		Water-cooled Units	
					Dimensions L x W x H (in.)	Weight (lb.) <sup>(5)</sup>	Dimensions L x W x H (in.)	Weight (lb.) <sup>(5)</sup>
CSG 55-2 CSG 55-2T CSG 55-2 RD	90	247	50	73	98 x 64 <sup>5</sup> / <sub>8</sub> x 84 <sup>1</sup> / <sub>2</sub>	5005	98 x 64 <sup>5</sup> / <sub>8</sub> x 77 <sup>1</sup> / <sub>2</sub>	5005
	125	192						
CSG 70-2 CSG 70-2 T CSG 70-2 RD	60	344	60	73		5093		5093
	90	298						
	125	245						
CSG 90-2 CSG 90-2 T CSG 90-2 RD	60	390	75	74		5236		5236
	90	342						
	125	296						
	145	273						
CSG 120-2 CSG 120-2 T CSG 120-2 RD	60	461	100	75		5545		5545
	90	459						
	125	421						
	145	420						
CSG 130-2 CSG 130-2 T CSG 130-2 RD	125	457	125	76	5820	5820		
	145	456						
DSG 140-2 DSG 140-2 RD	65	581	125	80	7496	6834		
	90	579						
	125	576						
	145	512						
DSG 180-2 DSG 180-2 RD	65	694	150	81	7826	7165		
	90	692						
	125	689						
	145	576						
DSG 220-2 DSG 220-2 RD	65	820	175	81	8157	7385		
	90	819						
	125	781						
	145	689						
DSG 260-2 DSG 260-2 RD	65	966	200	82	8378	7716		
	90	964						
	125	908						
	145	816						
DSG 290-2 DSG 290-2 RD	100	962	250	84	8819	8157		
	125	961						
	145	961						

Continued next page

Specifications are subject to change without notice.

# Fixed Speed Units—Continued

Model	Pressure Range <sup>(1)</sup> (psig)	FAD Complete Unit at Max Working Pressure Air-cooled (acfm) <sup>(2)</sup>	Rated Motor Power (hp)	Sound Level (dB(A)) <sup>(3)</sup>	Standard Air-cooled <sup>(4)</sup> Units		Water-cooled Units	
					Dimensions L x W x H (in.)	Weight (lb.) <sup>(5)</sup>	Dimensions L x W x H (in.)	Weight (lb.) <sup>(5)</sup>
FSG 300-2	90	1144	250	82	154½ x 81¾ x 107½	12,787	141⅜ x 82½ x 84	11,244
	125	1006						
	145	795						
FSG 350-2	65	1391	300	82	154½ x 81¾ x 107½	13,228	141⅜ x 82½ x 84	11,685
	90	1388						
	125	1261						
FSG 420-2	65	1591	350	83	154½ x 81¾ x 107½	13,779	141⅜ x 82½ x 84	12,236
	90	1589						
	125	1501						
FSG 500-2	125	1769	450	83	154½ x 81¾ x 107½	14,110	141⅜ x 82½ x 84	12,566
	145	1586						
FSG 501-2*	145	1766	450	77	N/A	N/A		12,566

For NOTES see page 26

\*Unit available water-cooled only

*Specifications are subject to change without notice.*



**Built for a lifetime.™**



[www.kaeser.com](http://www.kaeser.com)

**Kaeser Compressors, Inc.**  
511 Sigma Drive  
Fredericksburg, VA 22408 USA  
Telephone: 540-898-5500  
Toll Free: 800-777-7873  
info.usa@kaeser.com

**Kaeser Compressors Canada Inc.**  
3760 La Vérendrye Street  
Boisbriand, QC J7H 1R5 CANADA  
Telephone: (450) 971-1414  
Toll free: (800) 477-1416  
info.canada@kaeser.com

**Kaeser Compresores de México S de RL de CV**  
Calle 2 #123  
Parque Industrial Jurídica  
76100 Querétaro, Qro.  
Telephone: 01 (442) 218 64 48  
sales.mexico@kaeser.com

**Kaeser Compresores de Guatemala y Cia. Ltda.**  
Calz. Atanasio Tzul 21-00, zona 12  
El Cortijo II, Bodega 501  
01012-Guatemala City  
Telephone: +502 2412-6000  
info.guatemala@kaeser.com

Certified Management Systems

